

KCQ2 series

薄型气缸/Compact cylinder

φ12 φ16 φ20 φ25 φ32
φ40 φ50 φ63 φ80 φ100

规格/Specification

内径 (mm)	12	16	20	25	32	40	50	63	80	100
动作方式/Acting	双动型/单动型									
工作介质/Fluids	洁净空气									
使用压力 (MPa) Pressure range	单作用	0.25	0.18	0.17	0.15	0.13	-			
	双作用	0.07	0.05							
耐压力/Pressure-Resistance	1.0MPa									
工作温度/Fluids temp	-0~+70℃									
速度范围/Speed range	50 ~ 500 mm/s									
行程公差/Stroke length tolerance	+1.0 0 mm									
缓冲型式/Cushion type	无									
润滑型式/Lubrication	不需要									
接管口径/Port size	M5x0.8			1/8		1/4		3/8		

* 如需润滑, 请用透平1号油。

符号/Mark

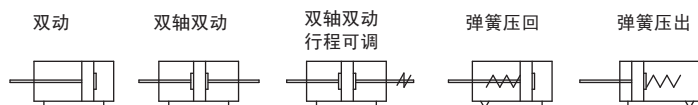

特性/Characteristic

- 1、执行JIS标准;
- 2、缸体与后盖, 活塞与活塞杆采用铆合结构, 紧凑可靠;
- 3、缸体内径滚压处理后再做硬质氧化处理, 耐磨、耐久性好;
- 4、活塞密封采用异形双向密封结构尺寸紧凑, 有储油功能;
- 5、紧凑型结构, 能有效节省安装空间;
- 6、缸体周边带有磁感应开关槽, 安装感应开关方便;
- 7、多种规格安装附件可供选择。

订购码/Ordering NO.

KC D Q2 W A - 20 - 50 D C - A73K S - XC16

内置磁环
无记号: 无内置磁环
D: 内置磁环

缸径

行程

缸身 (任选)

无记号: 杆端内螺纹
C: 橡胶缓冲
M: 杆端外螺纹
L: 长行程型

磁性开关

无记号: 无磁性开关
A54KL: 3m

缸筒材质

N: 无油润滑型
H: 低摩擦型

安装形式

B: 基本型
A: 两端内螺纹
W: 双杆型
L: 脚座型
F: 杆侧法兰型
G: 无杆侧法兰型
D: 双U型钩型

动作方式

D: 双动
S: 单动 (弹簧压回)
T: 单动 (弹簧压出)

磁性开关个数

无记号: 2个
S: 1个
N: n个

型号

无记号: 标准型
XC8: 行程可调型 (伸出型)
XC9: 行程可调型 (缩回型)
XC10: 双行程/双活塞杆型
XC11: 双行程/单活塞杆型
XC16: 无铜离子型



薄型气缸/Compact cylinder

行程/Stroke

内径 (mm)	标准行程 (mm)		最大行程		磁性开关
	双动	单动	双动	单动	
12	5 10 15 20 25 30	5 10 15 20	50	20	I-A73K I-A93K
16					
20	5 10 15 20 25 30 35 40 45 50	5 10 15 20 25 30	50	30	
25					
32	5 10 15 20 25 30 35 40 45 50 75 100	5 10 15 20 25 30	100	30	
40					
50	10 15 20 25 30 35 40 45 50 75 100	10 20	100	20	
63		-	100	-	
80					
100					

内部结构/Assembly Chart

■ KCQ series/不附磁型

■ KCDQ series/附磁型

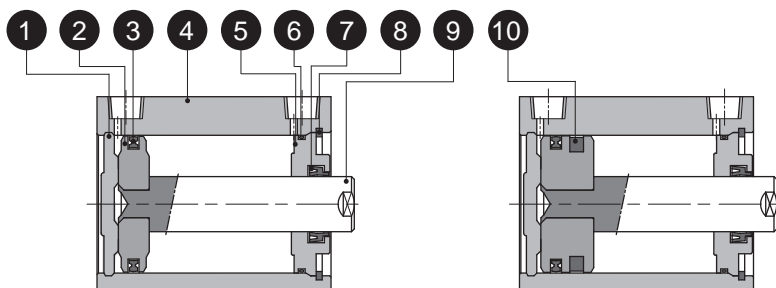

序号	零件名称	序号	零件名称
1	后盖	6	O型圈
2	活塞	7	杆密封圈
3	活塞密封圈	8	弹性挡圈
4	缸体	9	活塞杆
5	前盖	10	磁环

主要零件材质/Material Quality

零件名称	材质	零件名称	材质
前、后盖	铝合金	活塞密封圈	NBR
活塞杆	S45C镀硬铬	杆密封圈	NBR
缸筒	铝合金	O型圈	NBR
活塞	铝合金	磁环	稀土/塑胶

薄型气缸 (不附磁型) / Compact cylinder

外部规格/Dimensions

KCQ2B12 series

■ 不附磁型

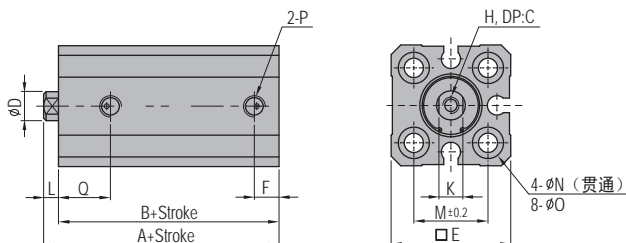

KCQ2B16 series

■ 不附磁型

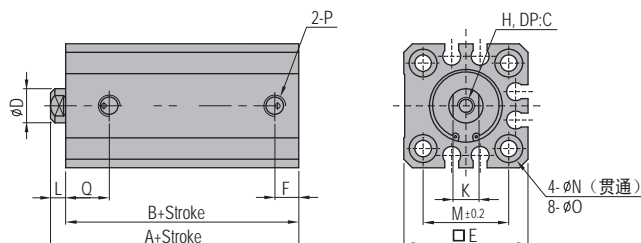

KCQ2B20,25 series

■ 不附磁型

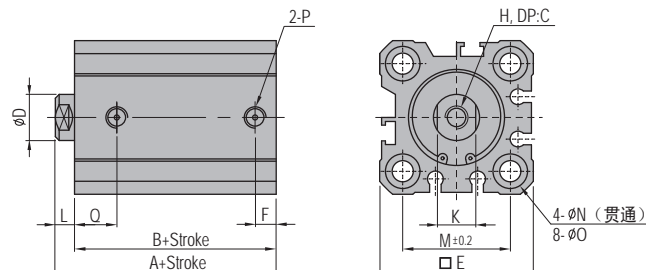

缸径 (mm)	行程范围	A	B	C	ϕD	$\square E$	F	H	L	M	ϕN	ϕO	P	K	Q
12	5-50	20.5	17	6	6	25	5	M3x0.5	3.5	15.5	3.5	6.5 DP:3.5	M5x0.8	5	10.5
16	5-50	22	18.5	8	8	29	5.5	M4x0.7	3.5	20	3.5	6.5 DP:3.5	M5x0.8	6	10
20	5-50	24	19.5	7	10	36	5.5	M5x0.8	4.5	25.5	5.5	9.0 DP:7.0	M5x0.8	8	10.5
25	5-50	27.5	22.5	12	12	40	5.5	M6x1.0	5	28	5.5	9.0 DP:7.0	M5x0.8	10	11

外部规格 / Dimensions

KCQ2B32~100 series

■ 不附磁型

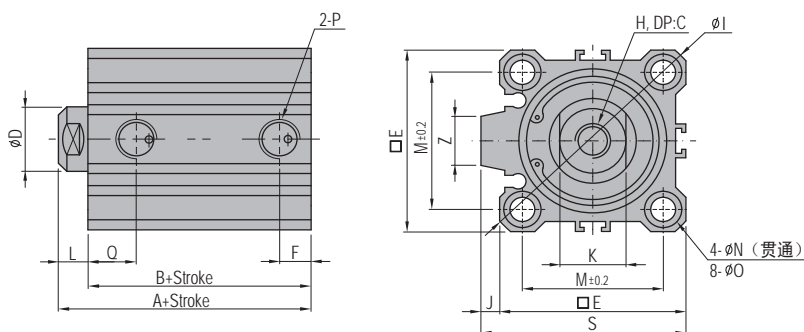

缸径 (mm)	行程范围	A	B	C	ϕD	$\square E$	F*	H	ϕI	J	K	L	M	ϕN	O	P*	Q*	S	Z
32	5~50	30	23	13	16	45	7.5	M8x1.25	60	4.5	14	7	34	5.5	9.0 DP:7.0	1/8	10.5	49.5	14
40	5~50	36	29.5	13	16	52	8	M8x1.25	69	5	14	7	40	5.5	9.0 DP:7.0	1/8	11	57	14
50	5~50	38.5	30.5	15	20	64	10.5	M10x1.5	86	7	17	8	50	6.6	11.0 DP:8.0	1/4	10.5	71	19
63	5~50	44	36	15	20	77	10.5	M10x1.5	103	7	17	8	60	9	14.0 DP:10.5	1/4	15	84	19
80	5~50	53.5	43.5	21	25	98	12.5	M16x2.0	132	6	22	10	77	11	17.5 DP:13.5	3/8	16	104	26
100	5~50	65	53	27	30	117	13	M20x2.5	156	6.5	27	12	94	11	17.5 DP:13.5	3/8	23	123.5	26

缸径 (mm)	mfg.Stroke	A	B	F	P	Q
32	75~100	40	33	7.5	1/8	10.5
40	75~100	46.5	39.5	8	1/8	11
50	75~100	48.5	40.5	10.5	1/4	10.5
63	75~100	54	46	10.5	1/4	15
80	75~100	63.5	53.5	12.5	3/8	16
100	75~100	75	63	13	3/8	23

- 注：1、带*尺寸为非硬性标准，可根据产品实际情况或客户需求作出适当变更；
2、标准行程无51~74，若有特定此范围内的行程需求，则规格建议按行程范围5~50的规格标准。



KCQ2

薄型气缸 (附磁型) / Compact cylinder

外部规格/Dimensions

KCDQ2B12 series

■ 附磁型

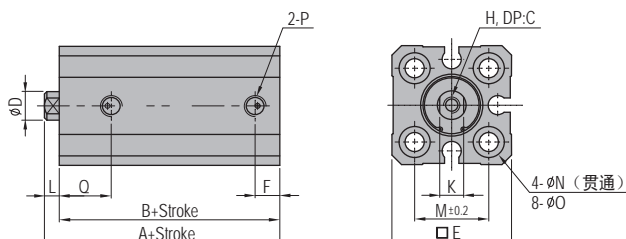

KCDQ2B16 series

■ 附磁型

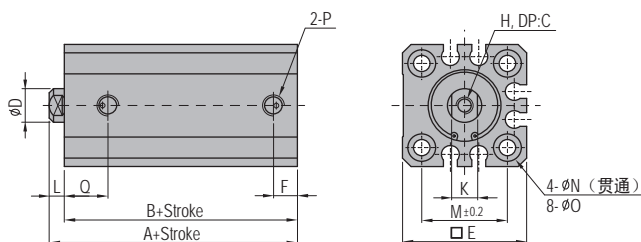

KCDQ2B20,25 series

■ 附磁型

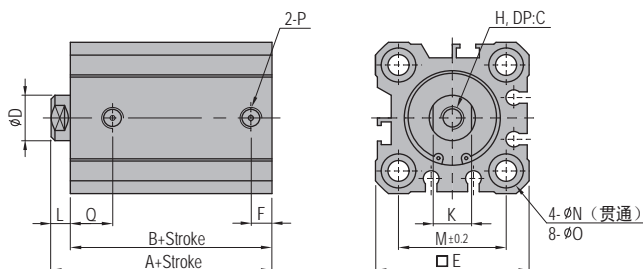

缸径 (mm)	行程范围	A	B	C	ϕD	$\square E$	F	H	L	M	ϕN	ϕO	P	K	Q
12	5-50	30.5	27	6	6	25	6.5	M3x0.5	3.5	15.5	3.5	6.5 DP:3.5	M5x0.8	5	10.5
16	5-50	32	28.5	8	8	29	5.5	M4x0.7	3.5	20	3.5	6.5 DP:3.5	M5x0.8	6	10
20	5-50	34	29.5	8	10	36	5.5	M5x0.8	4.5	25.5	5.5	9.0 DP:7.0	M5x0.8	8	10.5
25	5-50	37.5	32.5	12	12	40	5.5	M6x1.0	5	28	5.5	9.0 DP:7.0	M5x0.8	10	11

外部规格/Dimensions

KCDQ2B32~100 series

■ 附磁型

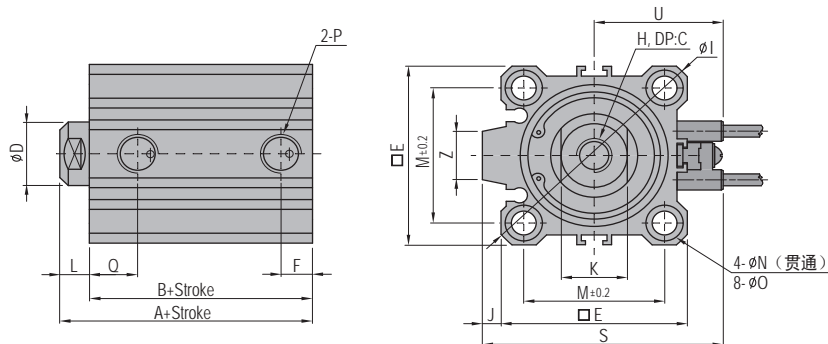

缸径 (mm)	行程范围	A	B	C	φD	□E	F*	H	φI	J	K	L	M	φN	O	P*	Q*	S	Z	U
32	5~100	40	33	13	16	45	7.5	M8x1.25	60	4.5	14	7	34	5.5	9.0 DP:7.0	1/8	10.5	58.5	18	31.5
40	5~100	46.5	39.5	13	16	52	8	M8x1.25	69	5	14	7	40	5.5	9.0 DP:7.0	1/8	12	66	18	35
50	5~100	48.5	40.5	15	20	64	10.5	M10x1.5	86	7	17	8	50	6.6	11.0 DP:8.0	1/4	11.5	80	22	41
63	5~100	54	46	15	20	77	10.5	M10x1.5	103	7	17	8	60	9	14.0 DP:10.5	1/4	15	93	22	47.5
80	5~100	63.5	53.5	21	25	98	12.5	M16x2.0	132	6	22	10	77	11	17.5 DP:13.5	3/8	16	112.5	26	57.5
100	5~100	75	63	27	30	117	13	M20x2.5	156	6.5	27	12	94	11	17.5 DP:13.5	3/8	23	132.5	26	67.5

注：带*尺寸为非硬性标准，可根据产品实际情况或客户需求作出适当变更。

外部规格/Dimensions

KCQ2B-M series

■ 杆端外螺纹型

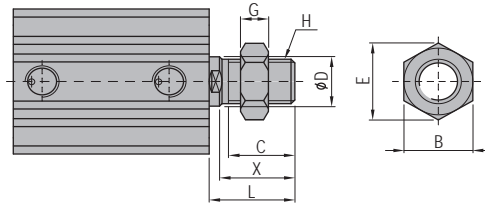

缸径 (mm)	B	C	φD	E	G	H	L	X
12	8	9	6	9.2	4	M5x0.8	14	10.5
16	10	10	8	11.5	5	M6x1.0	15.5	12
20	13	12	10	15	5	M8x1.25	18.5	14
25	17	15	12	19.6	6	M10x1.25	22.5	17.5
32	22	20.5	16	25.4	8	M14x1.5	28.5	23.5
40	22	20.5	16	25.4	8	M14x1.5	28.5	23.5
50	27	26	20	31.2	11	M18x1.5	33.5	28.5
63	27	26	20	31.2	11	M18x1.5	33.5	28.5
80	32	32.5	25	37	13	M22x1.5	43.5	35.5
100	41	32.5	30	47	16	M26x1.5	43.5	35.5

KCQ2A series

■ 缸筒两端内螺纹型

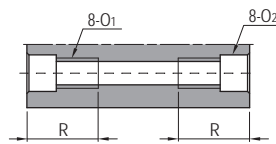

缸径 (mm)	O ₁	R	O ₂
12	M4x0.7	11	φ6.5 DP3.5
16	M4x0.7	11	φ6.5 DP3.5
20	M6x1.0	17	φ9 DP7
25	M6x1.0	17	φ9 DP7
32	M6x1.0	17	φ9 DP7
40	M6x1.0	17	φ9 DP7
50	M8x1.25	22	φ11 DP8
63	M10x1.5	26	φ14 DP10.5
80	M12x1.75	32	φ17.5 DP13.5
100	M12x1.75	32	φ17.5 DP13.5

薄型气缸/Compact cylinder

附件/Attachment

KCQ2-I series

I型单肘接头

φ12 · φ16 · φ20 · φ25

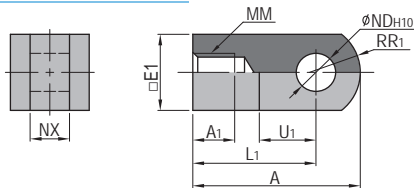

φ32 · φ40 · φ50 · φ63 · φ80 · φ100

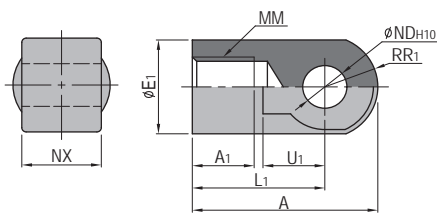

缸径 (mm)	A	A1	E1	L1	MM	RR1	U1	φND	NX
12	21.5	6	□10	16	M5x0.8	6.3	7	5 ^{+0.048} ₀	5 ^{-0.2} _{-0.4}
16	32	8	□12	25	M6x1.0	8.1	14	5 ^{+0.048} ₀	6.4 ^{-0.1} _{-0.3}
20	34	8.5	□16	25	M8x1.25	10.3	11.5	8 ^{+0.058} ₀	8 ^{-0.2} _{-0.4}
25	41	10.5	□20	30	M10x1.25	12.8	14	10 ^{+0.058} ₀	10 ^{-0.2} _{-0.4}
32, 40	42	14	φ22	30	M14x1.5	12	14	10 ^{+0.058} ₀	18 ^{-0.3} _{-0.5}
50, 63	56	18	φ28	40	M18x1.5	16	20	14 ^{+0.070} ₀	22 ^{-0.3} _{-0.5}
80	71	21	φ38	50	M22x1.5	21	27	18 ^{+0.070} ₀	28 ^{-0.3} _{-0.5}
100	79	21	φ44	55	M26x1.5	24	31	22 ^{+0.084} ₀	32 ^{-0.3} _{-0.5}

KCQ2-Y series

Y型双肘接头

φ12 · φ16 · φ20 · φ25

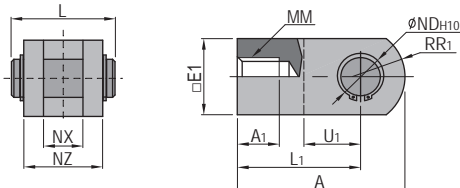

φ32 · φ40 · φ50 · φ63 · φ80 · φ100

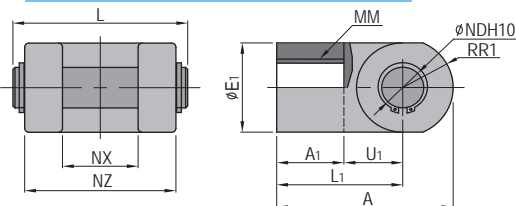

缸径 (mm)	A	A1	E1	L1	MM	RR1	U1	φND	NX	NZ	L
12	21.5	6	□10	16	M5x0.8	6.3	7	5 ^{+0.048} ₀	5 ^{+0.4} _{+0.2}	10	14.6
16	28	11	□12	21	M6x1.0	8.1	10	5 ^{+0.048} ₀	6.5 ^{+0.2} ₀	12	16.6
20	34	8.5	□16	25	M8x1.25	10.3	11.5	8 ^{+0.058} ₀	8 ^{+0.4} _{+0.2}	16	21
25	41	10.5	□20	30	M10x1.25	12.8	14	10 ^{+0.058} ₀	10 ^{+0.4} _{+0.2}	20	25.6
32, 40	42	16	φ22	30	M14x1.5	12	14	10 ^{+0.058} ₀	18 ^{+0.5} _{+0.3}	36	41.6
50, 63	56	20	φ28	40	M18x1.5	16	20	14 ^{+0.070} ₀	22 ^{+0.5} _{+0.3}	44	50.6
80	71	23	φ38	50	M22x1.5	21	27	18 ^{+0.070} ₀	28 ^{+0.5} _{+0.3}	56	64
100	79	24	φ44	55	M26x1.5	24	31	22 ^{+0.084} ₀	32 ^{+0.5} _{+0.3}	64	72

KCQ2-PIN series

肘节用接头

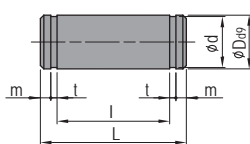

缸径 (mm)	φD	L	φd	l	m	t	缸径 (mm)	φD	L	φd	l	m	t
12	5 ^{-0.03} _{-0.06}	14.6	4.8	10.2	1.5	0.7	32, 40	10 ^{-0.03} _{-0.06}	41.6	9.6	36.2	1.55	1.15
16	5 ^{-0.03} _{-0.06}	16.6	4.8	12.2	1.5	0.7	50, 63	14 ^{-0.03} _{-0.06}	50.6	13.4	44.2	2.05	1.15
20	8 ^{-0.04} _{-0.076}	21	7.6	16.2	1.5	0.9	80	18 ^{-0.04} _{-0.076}	64	17	56.2	2.55	1.35
25	10 ^{-0.04} _{-0.076}	25.6	9.6	20.2	1.55	1.15	100	22 ^{-0.04} _{-0.076}	72	21	64.2	2.55	1.35



KCQ2

外部规格/Dimensions

KC(D)Q2B12-S series

■ 弹簧压回型

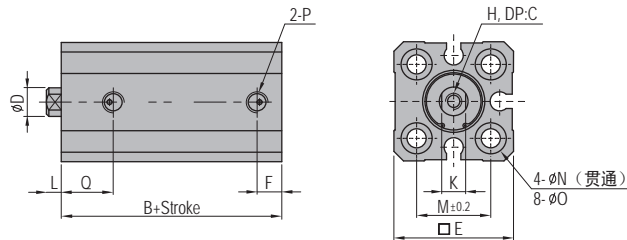

KC(D)Q2B16-S series

■ 弹簧压回型

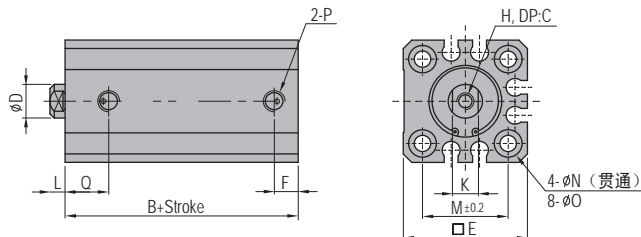

KC(D)Q2B (20~25) -S series

■ 弹簧压回型

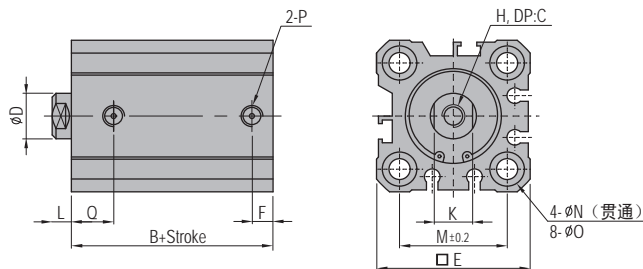

薄型气缸 (单动型弹簧压回) / Compact cylinder

外部规格 / Dimensions

KC(D)Q2B (32~50) -S series

■ 弹簧压回型

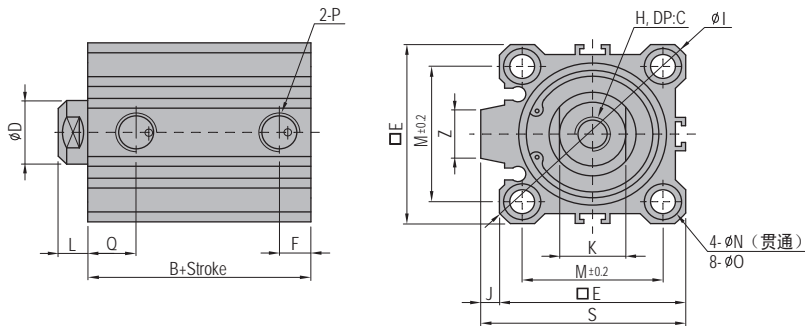

不附磁型

型号	B			ϕD	$\square E$	F		H	C	ϕI	J	K	L	M	ϕN	ϕO	P			Q		S	Z
	5st	10st	20st			5st	10st										5st	10st	20st	5st	10st		
KCQ2B12-S	22	27	-	6	25	5	5	M3x0.5	6	32	-	5	3.5	15.5	3.5	6.5 DP:3.5	M5x0.8	-	7.5	7.5	-	-	
KCQ2B16-S	23.5	28.5	-	8	29	5.5	5.5	M4x0.7	8	38	-	6	3.5	20	3.5	6.5 DP:3.5	M5x0.8	-	8	8	-	10	
KCQ2B20-S	24.5	29.5	-	10	36	5.5	5.5	M5x0.8	7	47	-	8	4.5	25.5	5.5	9.0 DP:7.0	M5x0.8	-	9	9	-	10	
KCQ2B25-S	27.5	32.5	-	12	40	5.5	5.5	M6x1.0	12	52	-	10	5	28	5.5	9.0 DP:7.0	M5x0.8	-	11	11	-	10	
KCQ2B32-S	28	33	-	16	45	5.5	5.5	M8x1.25	13	60	4.5	14	7	34	5.5	9.0 DP:7.0	M5x0.8	1/8	-	11.5	11.5	49.5	18
KCQ2B40-S	34.5	39.5	-	16	52	8	8	M8x1.25	13	69	5	14	7	40	5.5	9.0 DP:7.0	1/8	-	11	11	57	18	
KCQ2B50-S	-	40.5	50.5	20	64	10.5	10.5	M10x1.5	15	86	7	17	8	50	6.6	11.0 DP:8.0	-	1/4	10.5	10.5	71	22	

附磁型

型号	B		
	5st	10st	20st
KCDQ2B12-S	32	37	-
KCDQ2B16-S	33.5	38.5	-
KCDQ2B20-S	34.5	39.5	-
KCDQ2B25-S	37.5	42.5	-
KCDQ2B32-S	38	43	-
KCDQ2B40-S	44.5	49.5	-
KCDQ2B50-S	-	50.5	60.5



KCQ2-S

外部规格 / Dimensions

KC(D)Q2B12-T series

■ 弹簧压出型

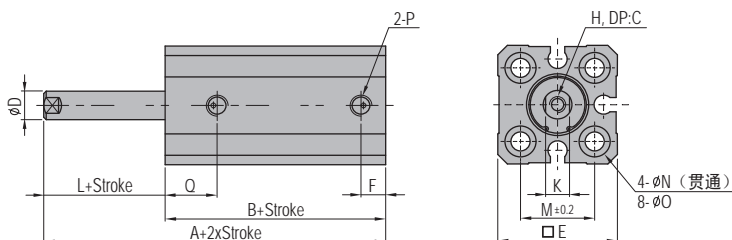

KC(D)Q2B16-T series

■ 弹簧压出型

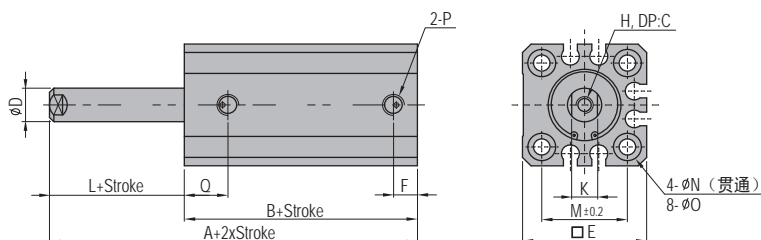

KC(D)Q2B (20,25) -T series

■ 弹簧压出型

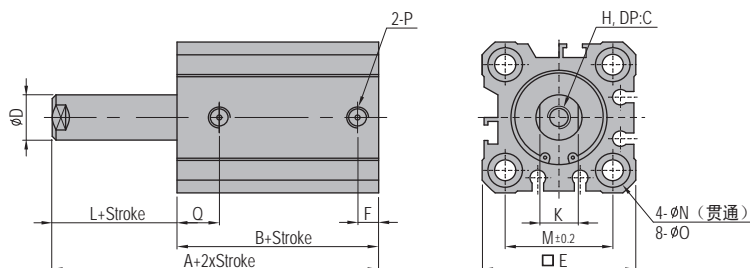

外部规格/Dimensions

KCQ2B (32~50) -T series

■ 弹簧压出型

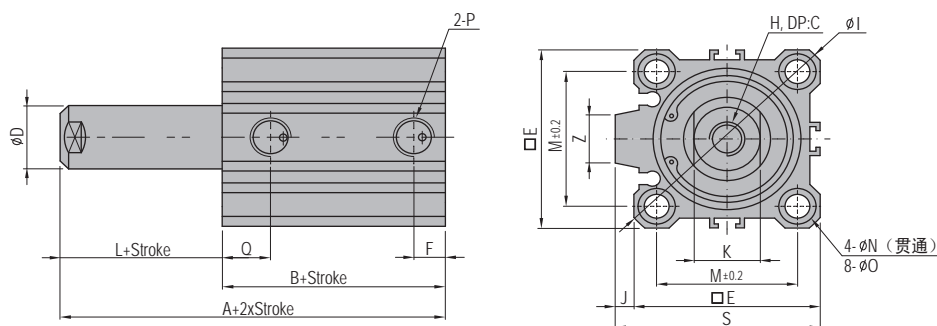

附磁型

型号	A		
	5st	10st	20st
KCDQ2B12-S	45.9	55.9	-
KCDQ2B16-S	44	54	-
KCDQ2B20-S	46	56	-
KCDQ2B25-S	47.5	57.5	-
KCDQ2B32-S	50	60	-
KCDQ2B40-S	56.5	66.5	-
KCDQ2B50-S	-	68.5	88.5

不附磁型

型号	A			ϕD	$\square E$	F		H	C	ϕI	J	K	L	M	ϕN	ϕO	P			Q		S	Z
	5st	10st	20st			5st	10st										5st	10st	20st	5st	10st		
KCQ2B12-S	30.5	40.5	-	6	25	8.5	13.5	M3x0.5	6	32	-	5	3.5	15.5	3.5	6.5 DP:3.5	M5x0.8	-	7.5	7.5	-	-	
KCQ2B16-S	32	42	-	8	29	8.5	13.5	M4x0.7	8	38	-	6	3.5	20	3.5	6.5 DP:3.5	M5x0.8	-	8	8	-	10	
KCQ2B20-S	34	44	-	10	36	9.5	14.5	M5x0.8	7	47	-	8	4.5	25.5	5.5	9.0 DP:7.0	M5x0.8	-	9	9	-	10	
KCQ2B25-S	37.5	47.5	-	12	40	10	15	M6x1.0	12	52	-	10	5	28	5.5	9.0 DP:7.0	M5x0.8	-	11	11	-	10	
KCQ2B32-S	40	50	-	16	45	12	17	M8x1.25	13	60	4.5	14	7	34	5.5	9.0 DP:7.0	M5x0.8	1/8	-	11.5	11.5	49.5	18
KCQ2B40-S	46.5	56.5	-	16	52	12	17	M8x1.25	13	69	5	14	7	40	5.5	9.0 DP:7.0	1/8	-	11	11	57	18	
KCQ2B50-S	-	58.5	78.5	20	64	-	18	M10x1.5	15	86	7	17	8	50	6.6	11.0 DP:8.0	-	1/4	10.5	10.5	71	22	

注：B尺寸与弹簧压回的尺寸相同。



KCQ2-T

薄型气缸 (双活塞杆不附磁型) / Compact cylinder

外部规格/Dimensions

KCQ2W12 series

■ 双活塞杆不附磁型

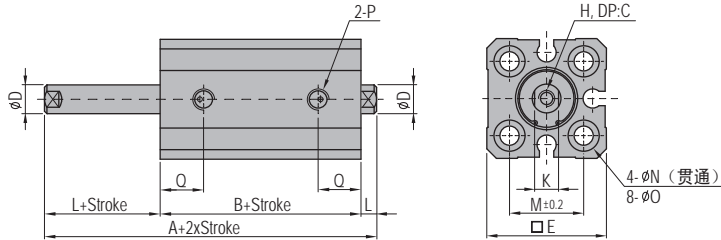

KCQ2W16 series

■ 双活塞杆不附磁型

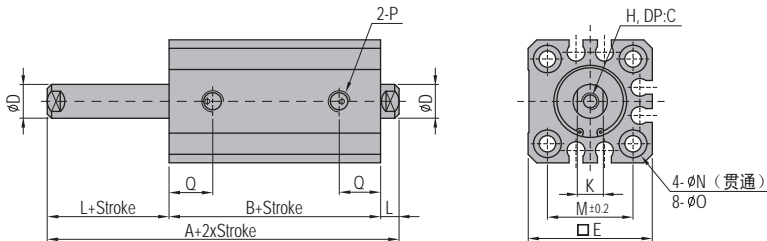

KCQ2W (20~25) series

■ 双活塞杆不附磁型

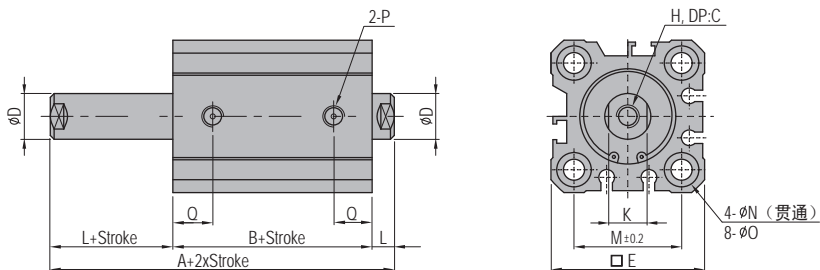

缸径 (mm)	行程范围	A	B	C	ϕD	$\square E$	H	L	M	ϕN	ϕO	P	K	Q
12	5-50	32.2	25.2	6	6	25	M3x0.5	3.5	15.5	3.5	6.5 DP:3.5	M5x0.8	5	10.5
16	5-50	33	26	8	8	29	M4x0.7	3.5	20	3.5	6.5 DP:3.5	M5x0.8	6	10
20	5-50	35	26	7	10	36	M5x0.8	4.5	25.5	5.5	9.0 DP:7.0	M5x0.8	8	10.5
25	5-50	39	29	12	12	40	M6x1.0	5	28	5.5	9.0 DP:7.0	M5x0.8	10	11

薄型气缸 (双活塞杆不附磁型) / Compact cylinder

外部规格/Dimensions

KCQ2W (32~100) series

■ 双活塞杆不附磁型

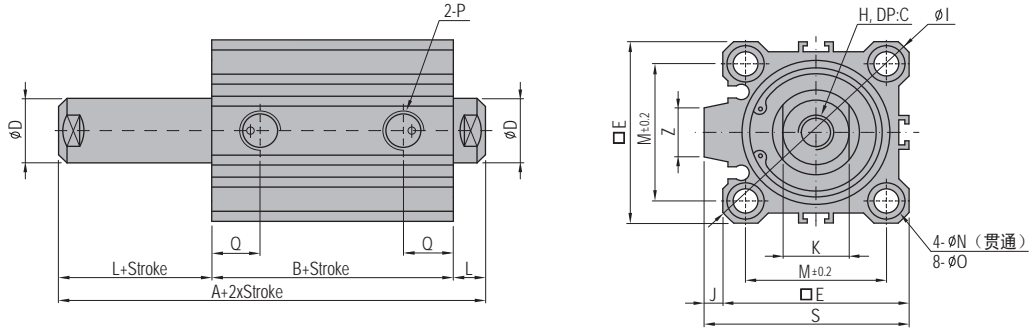

缸径 (mm)	行程范围	A	B	C	ϕD	$\square E$	H	ϕI	J	K	L	M	ϕN	O	P	Q	S	Z
32	5-50	44.5	30.5	13	16	45	M8x1.25	60	4.5	14	7	34	5.5	9.0 DP:7.0	1/8	10.5	49.5	18
40	5-50	54	40	13	16	52	M8x1.25	69	5	14	7	40	5.5	9.0 DP:7.0	1/8	12	57	18
50	10-50	56.5	40.5	15	20	64	M10x1.5	86	7	17	8	50	6.6	11.0 DP:8.0	1/4	11.5	71	22
63	10-50	58	42	15	20	77	M10x1.5	103	7	17	8	60	9	14.0 DP:10.5	1/4	15	84	22
80	10-50	71	51	21	25	98	M16x2.0	132	6	22	10	77	11	17.5 DP:13.5	3/8	16	104	26
100	10-50	84.5	60.5	21	30	117	M20x2.5	156	6.5	27	12	94	11	17.5 DP:13.5	3/8	23	124	26

KCQ2W (32~100) series

■ 双活塞杆不附磁长行程型

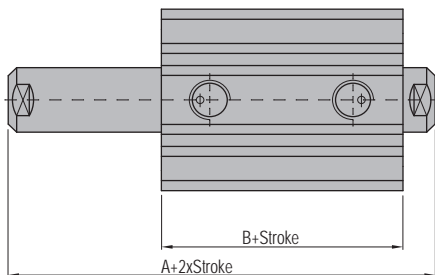

缸径 (mm)	A		B	
	55~75st	80~100st	55~75st	80~100st
32	129.5	154.5	115.5	140.5
40	139	164	125	150
50	141.5	166.5	125.5	150.5
63	143	168	127	152
80	156	181	136	161
100	169.5	194.5	145.5	170.5

注：缸筒两端带内螺纹尺寸、杆端带螺纹尺寸与基本型尺寸相同。

外部规格/Dimensions

KCDQ2W12 series

■ 双活塞杆附磁型

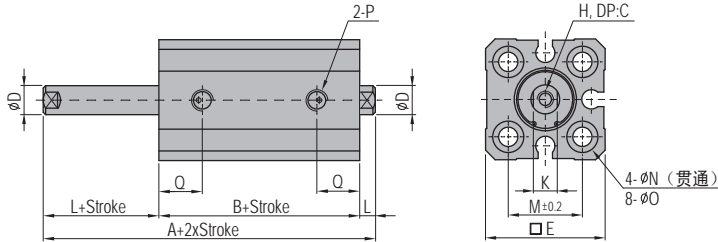

KCDQ2W16 series

■ 双活塞杆附磁型

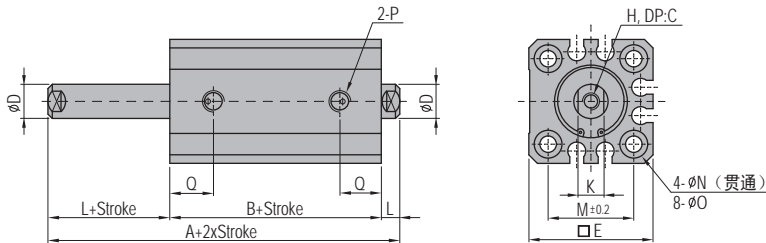

KCDQ2W (20,25) series

■ 双活塞杆附磁型

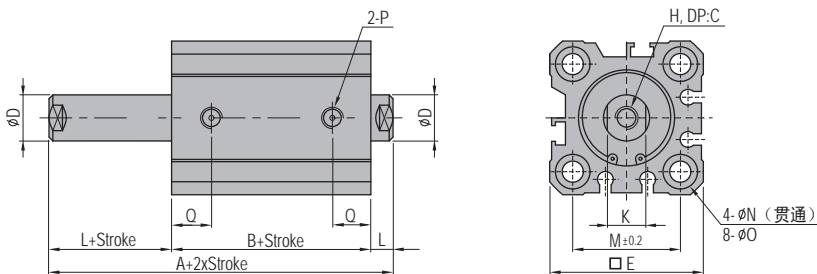

缸径 (mm)	行程范围	A	B	C	ϕD	$\square E$	H	L	M	ϕN	ϕO	P	K	Q
12	5~30	39.4	32.4	6	6	25	M3x0.5	3.5	15.5	3.5	6.5 DP:3.5	M5x0.8	5	10.5
16	5~30	43	36	8	8	29	M4x0.7	3.5	20	3.5	6.5 DP:3.5	M5x0.8	6	10
20	5~50	47	38	7	10	36	M5x0.8	4.5	25.5	5.5	9.0 DP:7.0	M5x0.8	8	10.5
25	5~50	49	39	12	12	40	M6x1.0	5	28	5.5	9.0 DP:7.0	M5x0.8	10	11

薄型气缸/Compact cylinder (双活塞杆附磁型)

外部规格/Dimensions

KCDQ2W (32~100) series

■ 双活塞杆附磁型

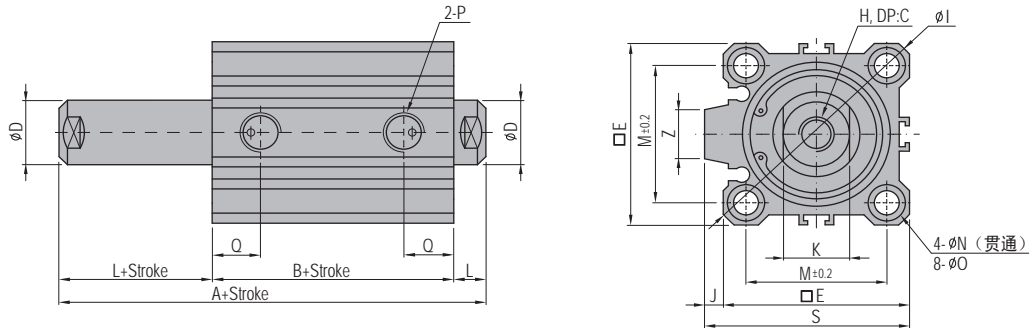

缸径 (mm)	行程范围	A	B	C	ϕD	$\square E$	H	ϕI	J	K	L	M	ϕN	O	P	Q	S	Z
32	5-50	54.5	40.5	13	16	45	M8x1.25	60	4.5	14	7	34	5.5	9.0 DP:7.0	1/8	10.5	58.5	18
40	5-50	64	50	13	16	52	M8x1.25	69	5	14	7	40	5.5	9.0 DP:7.0	1/8	12	66	18
50	10-50	66.5	50.5	15	20	64	M10x1.5	86	7	17	8	50	6.6	11.0 DP:8.0	1/4	11.5	80	22
63	10-50	68	52	15	20	77	M10x1.5	103	7	17	8	60	9	14.0 DP:10.5	1/4	15	93	22
80	10-50	81	61	21	25	98	M16x2.0	132	6	22	10	77	11	17.5 DP:13.5	3/8	16	112.5	26
100	10-50	94.5	70.5	27	30	117	M20x2.5	156	6.5	27	12	94	11	17.5 DP:13.5	3/8	23	132.5	26

KCDQ2W (32~100) series

■ 双活塞杆附磁长行程型

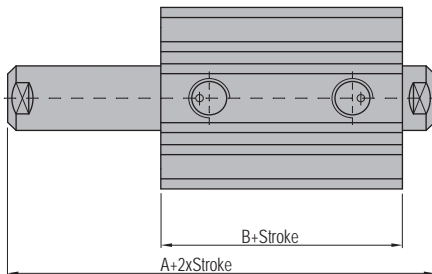

缸径 (mm)	A		B	
	55-75st	80-100st	55-75st	80-100st
32	129.5	154.5	115.5	140.5
40	139	164	125	150
50	141.5	166.5	125.5	150.5
63	143	168	127	152
80	156	181	136	161
100	169.5	194.5	145.5	170.5

注：缸筒两端带内螺纹尺寸、杆端带螺纹尺寸与基本型尺寸相同。

外部规格/Dimensions

KCQ2-XC8 series

行程可调型(伸出型)

KC(D)Q2 **缸径** **安装形式** - **行程** - **调节范围** -XC8

符号

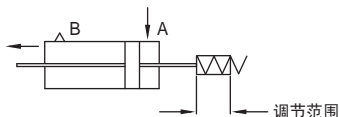

规格

0 ≤ Stroke < 25 调节范围 0 ~ 10mm
 25 ≤ Stroke < 50 调节范围 0 ~ 25mm
 Stroke ≥ 50 调节范围 0 ~ 50mm

结构尺寸

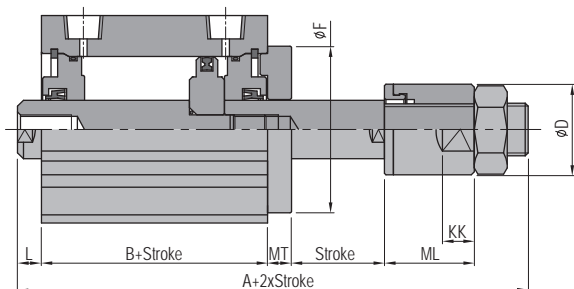

缸径 (mm)	行程范围	A	B	φF	φG	KK	L	ML	MT
16	10~100	58.5	26	28	14	7	3.5	19	5
20	10~100	67.5	26	36	20	10	4.5	22.5	8
25	10~100	71	29	40	20	10	5	22.5	8
32	10~100	78.5	30.5	38	27	14	7	26	6
40	10~100	88	40	46	27	14	7	26	6
50	10~100	100.5	40.5	57	35	16	8	30	8
63	10~100	102	42	68	35	16	8	30	10
80	10~100	125	51	90	48	20	10	38	12
100	10~100	138.5	60.5	110	48	20	12	38	14

*其它尺寸与基本型相同。

KCQ2-XC9 series

行程可调型(缩回型)

KC(D)Q2 **缸径** **安装形式** - **行程** - **调节范围** -XC9

符号

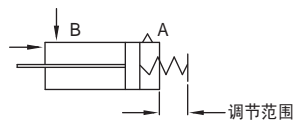

规格

0 ≤ Stroke < 25 调节范围 0 ~ 10mm
 25 ≤ Stroke < 50 调节范围 0 ~ 25mm
 Stroke ≥ 50 调节范围 0 ~ 50mm

结构尺寸

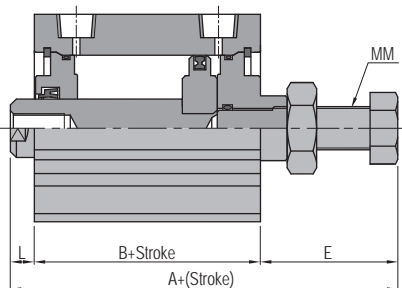

缸径 (mm)	行程范围	A	B	E	MM	L
20	5~50	61 (73)	26 (38)	30.5	M8x1.25	4.5
25	5~50	63.5 (73.5)	29 (39)	29.5	M8x1.25	5
32	5~50	65.5 (75.5)	30.5 (40.5)	28	M8x1.25	7
40	5~50	84 (94)	40 (50)	37	M8x1.5	7
50	10~50	84.5 (94.5)	40.5 (50.5)	36	M8x1.25	8
63	10~50	88.5 (98.5)	42 (52)	38.5	M8x1.5	8
80	10~50	109.5 (119.5)	51 (61)	48.5	M8x1.5	10
100	10~50	125 (135)	60.5 (70.5)	52.5	M8x1.5	12

*其它尺寸与基本型相同。

* () 为带磁性开关的尺寸。

外部规格/Dimensions

KCQ2-XC10 series

■ 双活塞杆/双行程型

KC (D) Q2B 缸径 行程A + 行程B - XC10

■ 符号

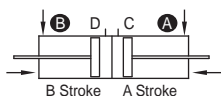

当A、B口同时进气时，
A、B行程同时缩回。

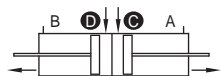

当D、C口同时进气时，
A、B行程同时伸出。

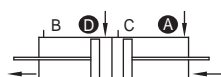

当A、D口同时进气时，
B行程伸出、A行程缩回。

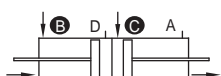

当B、C口同时进气时，
A行程伸出、B行程缩回。

*两个气缸以背靠背形式组成一个气缸，使气缸行程分三步控制。

■ 规格

类型	无润滑
缸径 (mm)	φ16 - φ100
动作方式	双动
流体	空气
安装方式	通孔

■ 结构尺寸

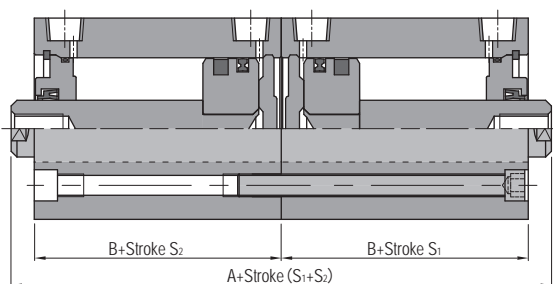

缸径 (mm)	行程范围	A		B	
		0-50	75-100	0-50	75-100
12	5-30	41 (63)	-	17 (28)	-
16	5-30	44 (68)	-	18.5 (30.5)	-
20	5-50	48 (72)	-	19.5 (31.5)	-
25	5-50	55 (75)	-	22.5 (32.5)	-
32	5-100	60 (80)	80 (80)	23 (33)	33 (33)
40	5-100	73 (93)	93 (93)	29.5 (39.5)	39.5 (39.5)
50	10-100	77 (97)	97 (97)	30.5 (40.5)	40.5 (40.5)
63	10-100	88 (108)	108 (108)	36 (46)	46 (46)
80	10-100	107 (127)	127 (127)	43.5 (53.5)	53.5 (53.5)
100	10-100	130 (150)	150 (150)	53 (63)	63 (63)

*其它尺寸与基本型相同。

* () 为带磁性开关的尺寸。



KCQ2-XC10

外部规格/Dimensions

KCQ2-XC11 series

■ 单活塞杆/双行程型

KC(D)Q2B (缸径) (行程A) + (行程B-A) - XC11

■ 符号

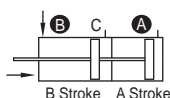

当B口进气时，
A、B行程都缩回。

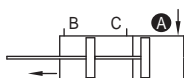

当A口进气时，
活塞杆伸出A行程。

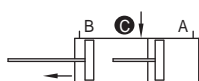

当C口继续供气时，
活塞杆继续伸出，行程为B-A。

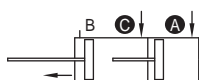

当A、C口同时供气时，
在行程A范围内可得到2倍输出力。

*两个气缸连成一个气缸，可实现行程两种方式控制，并得到双倍输出力。

■ 规格

类型	无润滑
缸径 (mm)	φ12 ~ φ100
动作方式	双动
流体	空气
安装方式	通孔

■ 结构尺寸

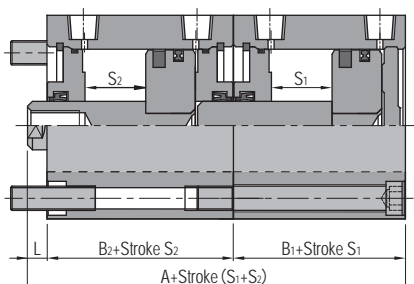

缸径 (mm)	A	B ₁	B ₂	L
20	50 (74)	19.5 (31.5)	26 (38)	4.5
25	56.5 (76.5)	22.5 (32.5)	29 (39)	5
32	60.5 (80.5)	23 (33)	30.5 (40.5)	7
40	76.5 (96.5)	29.5 (39.5)	40 (50)	7
50	79 (99)	30.5 (40.5)	40.5 (50.5)	8
63	86 (106)	36 (46)	42 (52)	8
80	104.5 (124.5)	43.5 (53.5)	51 (61)	10
100	125.5 (145.5)	53 (63)	60.5 (70.5)	12

*其它尺寸与基本型相同。
*() 为带磁性开关的尺寸。

外部规格 / Dimensions

KCQ2-L series

■ 长行程型

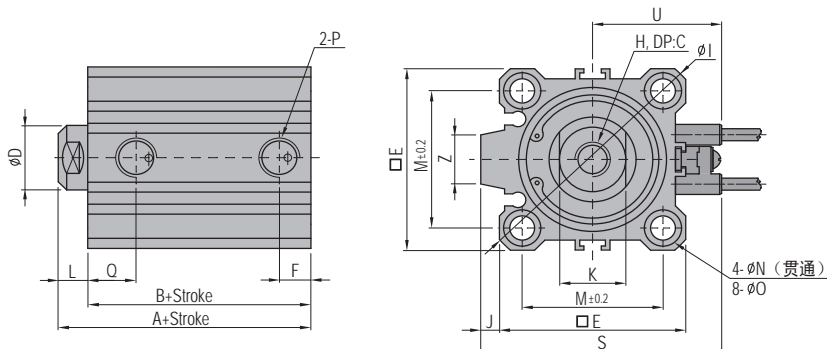

缸径 (mm)	行程范围	A	B	C	ØD	ØE	G	H	ØI	J	K	L	M	O	P	Q	R	S	T	Z	U
32	125-300	62.5	45.5	13	16	45	5	M8x1.25	60	4.5	14	17	34	M6x1.0	1/8	12.5	10	58.5	22 ⁰ _{-0.052}	18	31.5
40	125-300	72	55	13	16	52	5	M8x1.25	69	5	14	17	40	M6x1.0	1/8	14	10	66	28 ⁰ _{-0.052}	18	35
50	125-300	73.5	55.5	15	20	64	5	M10x1.5	86	7	17	18	50	M8x1.25	1/4	14	14	80	35 ⁰ _{-0.062}	22	41
63	125-300	75	57	15	20	77	5	M10x1.5	103	7	17	18	60	M10x1.5	1/4	16.5	18	93	35 ⁰ _{-0.062}	22	47.5
80	125-300	86	66	21	25	98	5	M16x2.0	132	6	22	20	77	M12x1.75	3/8	19	22	112.5	43 ⁰ _{-0.062}	26	57.5
100	125-300	97.5	75.5	27	30	117	5	M20x2.5	156	6.5	27	22	94	M12x1.75	3/8	23	22	132.5	59 ⁰ _{-0.074}	26	67.5

- 注：1、该型号标准行程无101-124，若有特定需要在此范围内的行程，则推荐按照前页面标准行程75-100规格选型，与本页选型规格无关；
2、该型号产品带橡胶缓冲，选型编码无需填写“DC”或“DCM”。

KCQ2-L-M series

■ 杆端外螺纹型

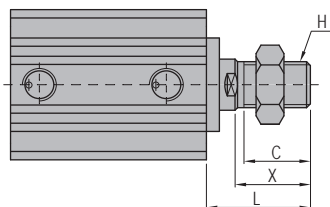

缸径 (mm)	C	H	L	X
32	20.5	M14x1.5	38.5	23.5
40	20.5	M14x1.5	38.5	23.5
50	26	M18x1.5	43.5	28.5
63	26	M18x1.5	43.5	28.5
80	32.5	M22x1.5	53.5	35.5
100	32.5	M26x1.5	53.5	35.5